



MODEL 1501 | Glass Door | Specification Sheet
Commercial Series • Step & Marker • LED

TYPE: MODEL:
PROJECT:

PRODUCT FEATURES



Wattage	6 W [WHITE]	4.5 W [AMBER]
Voltage	120 – 277 VAC	
Lumens	210 Delivered Lumens [WHITE]	75 Delivered Lumens [AMBER]
Distribution	Forward Throw with ± 15° of Adjustment	
CCT	2700K, 3000K, 3500K, 4000K [WHITE]	595nm [AMBER]
CRI	80 CRI min. [WHITE]	
Dimming	0-10V or Phase Cut (TRIAC/ELV-120VAC only) available	
Driver	Constant current Class 2 Output	
Dimensions	6" W x 4" H x 4 5/8" D	



ORDERING INFORMATION

EXAMPLE: 1501-GB-B-27-MV-PCT-CP-ER-1501-1

MODEL	DOOR COVER	FINISH	COLOR TEMP	VOLTAGE	DIMMING	HOUSING	MOUNTING	ACCESSORIES
1501	GB	B		MV		CP		

MODEL	DOOR COVER	FINISH	COLOR TEMP	VOLTAGE
1501	GB Glass Border	B Black	27 2700°K 30 3000°K 35 3500°K 40 4000°K AMB 595 nm	MV Multi Volt
DIMMING	HOUSING	MOUNTING	ACCESSORIES	ORDERING NOTES
ND Non Dimming 010 0-10V PCT Phase Cut (TRIAC/ELV-120VAC only)	CP Composite	FT Flush Tray * FLUSH TRAY OPTIONAL No code required for standard mounting.	ER-1501-1 (1 Extension Ring) ER-1501-2 (2 Extension Rings) ER-1501-3 (3 Extension Rings) DF1 Diffuser Film	* Flush tray optional. No code required for standard mounting. Standard Mounting: Door cover will sit proud of front face of Rough-in box (typically finished surface) by 5/8".



PROFESSIONAL
OUTDOOR LIGHTING

www.VistaPro.com • email@vistapro.com • Fax: (888) 670-VISTA (8478)
1625 Surveyor Avenue • Simi Valley, CA 93063 • (805) 527-0987 • (800) 766-VISTA (8478)

Vista Professional Outdoor Lighting reserves the right to modify the design and/or construction of the fixture shown without further notification.



SPECIFICATIONS

HOUSING:

Injection-molded fiber-reinforced polymer Rough-in box with threaded brass inserts. UV stable.

DOOR COVER / LENS:

Tempered, shock and heat-resistant soda-lime glass. Door cover will sit proud of front face of Rough-in box (typically finished surface) by $\frac{5}{8}$ ". For a flush door cover appearance, the Flush Tray (FT) mounting must be used.

FINISH:

Glass Border available in Black.

REFLECTOR:

Extruded aluminum, satin etched. Adjustable $\pm 15^\circ$ from preset 0° position.

MOUNTING:

Rough-in box designed for installation in concrete, brick/block, wood frame construction (non-IC) and insulated walls (IC).

FASTENERS/INSERTS:

All fasteners are stainless steel.

CERTIFICATIONS | STANDARDS | COMPLIANCE:

- UL Certified for wet locations (USA & Canada) | (UL 1598)
- Ingress Protection Rating: **IP66**
- Buy American Act (**BAA**)
- Build America, Buy America Act (**BABA**)

LED:

Integrated LED module.

- **White:** 210 Lumens delivered | 6 Watts
- **Amber:** 75 Lumens delivered | 4.5 Watts

COLOR TEMPERATURE:

- **White:** 2700K, 3000K, 3500K or 4000K CCT
- **Amber:** 595 nM

COLOR RENDERING:

80 CRI minimum [WHITE]

BUG RATING:

- **White:** B0 – U2 – G1
- **Amber:** B0 – U1 – G0

OPTICS/AIMING:

No-glare optics. Hot-aiming adjustable performance optic assembly. 30° of adjustment for precise beam control.

DRIVER:

Integral cUL listed Class 2 LED driver, either non-dimmable ND or dimmable. Dimming: 0-10V and Phase Cut (TRIAC/ELV-120VAC only) options available.

ELECTRICAL:

Universal voltage input (120- 277VAC) Suitable for through branch wiring. Four $\frac{1}{2}$ " NPT conduit entry hubs with knockout membrane standard.

DIMENSIONS

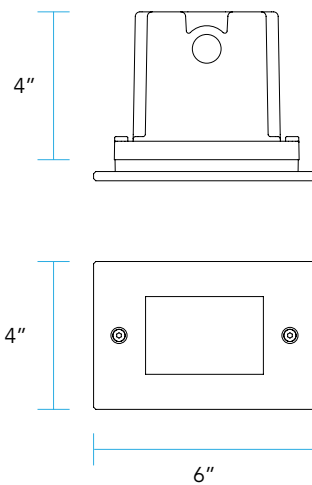

IMPORTANT NOTE:

Door cover will sit proud of front face of Rough-in box (typically finished surface) by $\frac{5}{8}$ ". For a flush Door Cover appearance, the Flush Tray (FT) MOUNTING must be used.

