



MODEL 1501 | Gradient | Specification Sheet
Commercial Series • Step & Marker • LED

TYPE: MODEL:
PROJECT:

PRODUCT FEATURES



Wattage	6 W
Voltage	120 – 277 VAC
Lumens	210 Delivered Lumens
Distribution	Forward Throw with ± 15° of Adjustment
CCT	2700K, 3000K, 3500K, 4000K
CRI	80 CRI min.
Dimming	0-10V or Phase Cut (TRIAC/ELV-120VAC only) available
Driver	Constant current Class 2 Output
Dimensions	5¼" W x 3¼" H x 4⅝" D

ORDERING INFORMATION

EXAMPLE: 1501-BL2-BSN-27-MV-PCT-CP-ER-1501-1

MODEL	DOOR COVER	FINISH	COLOR TEMP	VOLTAGE	DIMMING	HOUSING	MOUNTING	ACCESSORIES
1501				MV		CP		

MODEL	DOOR COVER	FINISH	COLOR TEMP	VOLTAGE
1501	BL2 Brass Gradient Door	SS Stainless Steel *	27 2700°K	MV Multi Volt
	SL2 Stainless Steel Gradient Door	BSN Natural Brass **	30 3000°K	
		BSO Olde Brass **	35 3500°K	
			40 4000°K	
			AMB 595 nm	
DIMMING	HOUSING	MOUNTING	ACCESSORIES	ORDERING NOTES
ND Non Dimming 010 0-10V PCT Phase Cut (TRIAC/ELV-120VAC only)	CP Composite	FT Flush Tray ***	ER-1501-1 (1 Extension Ring) ER-1501-2 (2 Extension Rings) ER-1501-3 (3 Extension Rings) DF1 Diffuser Film	* Stainless Steel Doors only. ** Brass Doors only. *** Flush tray optional. No code required for standard mounting.



PROFESSIONAL
OUTDOOR LIGHTING

www.VistaPro.com • email@vistapro.com • Fax: (888) 670-VISTA (8478)
1625 Surveyor Avenue • Simi Valley, CA 93063 • (805) 527-0987 • (800) 766-VISTA (8478)

Vista Professional Outdoor Lighting reserves the right to modify the design and/or construction of the fixture shown without further notification.



SPECIFICATIONS

HOUSING:

Injection-molded fiber-reinforced polymer Rough-in box with threaded brass inserts. UV stable.

DOOR COVER:

Option of stamped brass or stamped stainless steel.

LENS:

Clear, tempered, shock and heat-resistant soda-lime glass lens.

REFLECTOR:

Extruded aluminum, satin etched. Adjustable $\pm 15^\circ$ from preset 0° position.

MOUNTING:

Rough-in box designed for installation in concrete, brick/block, wood frame construction (non-IC) and insulated walls (IC).

FASTENERS/INSERTS:

All fasteners are stainless steel.

CERTIFICATION:

UL Listed to U.S. & Canadian (cUL) safety standards (UL 1598). Suitable for wet locations. IP66.

LED:

Integrated LED module. 6 Watts and 210 Delivered Lumens.

COLOR TEMPERATURE:

2700°K, 3000°K, 3500°K or 4000°K CCT White.

COLOR RENDERING:

80 CRI minimum

OPTICS/AIMING:

No-glare optics. Hot-aiming adjustable performance optic assembly. 30° of adjustment for precise beam control.

DRIVER:

Integral cUL listed Class 2 LED driver, either non-dimmable ND or dimmable. Dimming: 0-10V and Phase Cut (TRIAC/ELV-120VAC only) options available.

ELECTRICAL:

Universal voltage input (120- 277VAC) Suitable for through branch wiring. Four $\frac{1}{2}$ " NPT conduit entry hubs with knockout membrane standard.

DIMENSIONS

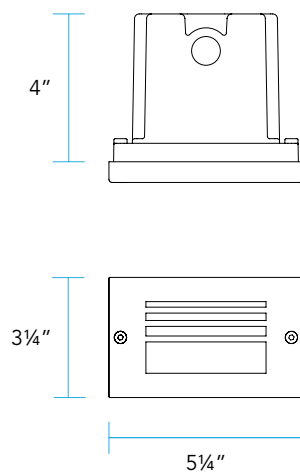

IMPORTANT NOTE:

Door cover will sit proud of front face of Rough-in box (typically finished surface) by $\frac{5}{8}$ ".
For a flush Door Cover appearance, the Flush Tray (FT) MOUNTING must be used.

