



INSTALLATION INSTRUCTIONS

IMPORTANT NOTE:

- Luminaire must be installed and grounded in accordance with the National Electrical Code (NEC) and local codes.
- Luminaire is UL listed for above grade installation only.
- Always use UL recognized wire connectors for connections.

MAINTENANCE: To assure proper operation and efficiency and to prevent luminaire overheating, lens must be kept clean and free of dirt, dust, leaves, trash and mineral deposits from water. A regular schedule maintenance program is recommended.

SAFETY WARNING: Luminaire can become very hot depending on the lamp wattage used. Lens and housing around the lamp can become hot enough to blister hands. Particular care should be taken not to locate luminaires where small children can reach them if high wattage lamps are used.

NOTE: Save these instructions for future reference.



LUMINAIRE MOUNTING:

1. Make sure electrical supply is off at circuit breaker before starting luminaire installation or servicing.
2. Thread luminaire onto junction box or other mounting device until it is at desired direction using thread sealant.
3. Attach luminaire leads to line in leads observing polarity, black to black, white to white and green to ground using silicone filled safety connectors (provided).
4. Attach junction box cover with luminaire to junction box (by others). Make sure not to pinch wires that may be sandwiched between cover and box.
5. Coat exposed luminaire threads with thread sealant to keep moisture from entering junction box or other mounting device.
6. Install lamp.
7. Install shade and lens and tighten screws evenly.
8. Supply power to the luminaire and check for proper operation.

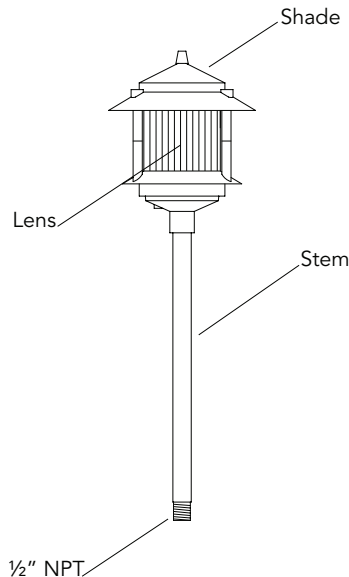

IMPORTANT SAFETY INSTRUCTIONS - THE LIGHTED LAMP IS HOT!

WARNING - TO REDUCE THE RISK OF FIRE, OR INJURY TO PERSONS:

1. Turn off/unplug and allow to cool before replacing lamp.
2. Lamps get hot! Contact only switch/plug when turning on.
3. Do not touch hot lens, guard or enclosure.
4. Keep lamp away from material that may burn.
5. Do not operate luminaire fitting with a missing or damaged cover.

SAVE THESE INSTRUCTIONS (Leave with property owner/manager)

LAMP INSTALLATION/REPLACEMENT:

CAUTION: Do not exceed maximum wattage marked on luminaire label.

1. To prevent electrical shock, disconnect from electrical supply before service.
2. Using a Phillips screw driver, turn blade screws to open position (do not remove blade screws).
3. Remove shade to expose globe lens.
4. Unscrew globe lens counter clockwise and remove to expose lamp.
5. Replace lamp with correct wattage and type marked on fixture label.
6. Replace globe lens and shade.
7. Turn blade screws to closed position.

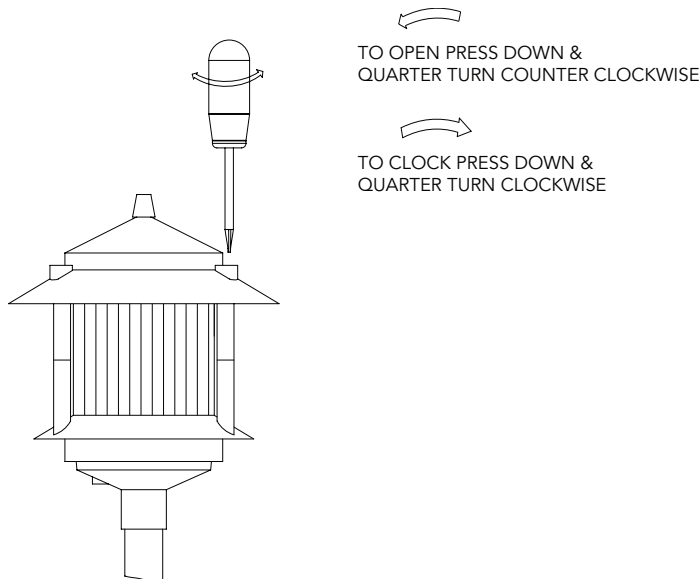

Lamp Information		
Model	Lamp Type	Max Watts
1207	A19	75



INSTALLATION INSTRUCTIONS

IMPORTANT NOTE:

- Luminaire must be installed and grounded in accordance with the National Electrical Code (NEC) and local codes.
- Luminaire is UL listed for above grade installation only.
- Always use UL recognized wire connectors for connections.

MAINTENANCE: To assure proper operation and efficiency and to prevent luminaire overheating, lens must be kept clean and free of dirt, dust, leaves, trash and mineral deposits from water. A regular schedule maintenance program is recommended.

SAFETY WARNING: Luminaire can become very hot depending on the lamp wattage used. Lens and housing around the lamp can become hot enough to blister hands. Particular care should be taken not to locate luminaires where small children can reach them if high wattage lamps are used.

NOTE: Save these instructions for future reference.



LUMINAIRE MOUNTING:

1. Make sure electrical supply is off at circuit breaker before starting luminaire installation or servicing.
2. Thread luminaire onto junction box or other mounting device until it is at desired direction using thread sealant.
3. Attach luminaire leads to line in leads observing polarity, black to black, white to white and green to ground using silicone filled safety connectors (provided).
4. Attach junction box cover with luminaire to junction box (by others). Make sure not to pinch wires that may be sandwiched between cover and box.
5. Coat exposed luminaire threads with thread sealant to keep moisture from entering junction box or other mounting device.
6. Install lamp.
7. Install shade and lens and tighten screws evenly.
8. Supply power to the luminaire and check for proper operation.

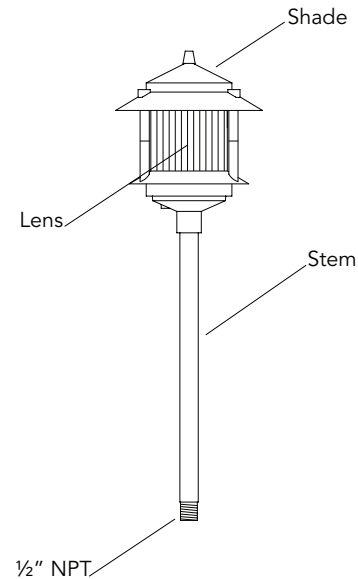

LED ENGINE INSTALLATION/REPLACEMENT:

1. To prevent electrical shock, disconnect transformer from electrical supply before service.
2. Using a Phillips screw driver, turn blade screws to open position (do not remove blade screws).
3. Remove shade to expose globe lens.
4. Unscrew globe lens counter clockwise and remove to expose emitter.
5. Remove stainless steel locking/expansion ring.
6. Pull up field replaceable LED engine assembly.
7. Disconnect connector assembly.
8. Connect new field replaceable LED engine to connector assembly.
9. Reinstall LED engine and secure with stainless steel locking/expansion ring.
10. Reinstall shade and lens and secure with spring loaded locking pins.

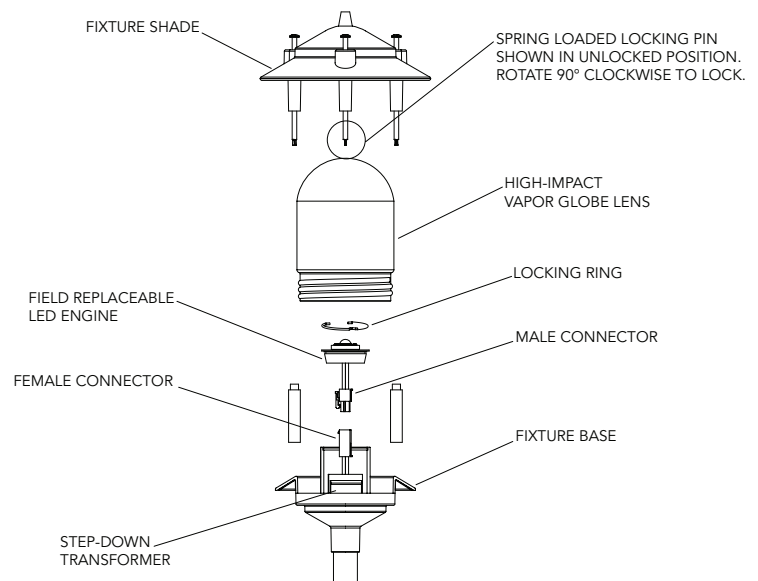

Vista Professional Outdoor Lighting reserves the right to modify the design and/or construction of the fixture shown without further notification.