



MODEL 3108 | Specification Sheet
Commercial Series • Low Voltage • Up / Accent / Downlight

TYPE: MODEL:
PROJECT:

PRODUCT FEATURES



Wattage	4.5 – 13 W
Voltage	9 – 15 VAC
Lumens	135 – 738 Delivered Lumens
Distribution	16° (VNS), 19° (NS), 30° (MF), 45° (WF)
CCT	2700K, 3000K, 3500K, 4000K, 5000K
CRI	80 CRI min.
Housing	Die-cast Aluminum
Dimensions	3" DIA x 8 5/8" D



ORDERING INFORMATION

EXAMPLE: GR-3108-B-9.5-27-SP-HL

MOUNTING	MODEL	FINISH	WATTAGE	COLOR TEMP	DISTRIBUTION	ACCESSORIES
	3108					

MOUNTING	MODEL	FINISH			
GR ABS ground stake WR Wall-mount canopy TR Tree-mount junction box	3108	B Black Z Architectural Bronze DZ Dark Bronze GT Granite W White	BR Architectural Brick LZ Light Bronze SB Special Bronze GG Glossy Gray R Rust HG Hunter Green WB Weathered Bronze WI Weathered Iron GM Graphite Metallic	G Verde P Pewter M Mocha OF Olde Finish	
WATTAGE	COLOR TEMPERATURE	DISTRIBUTION	ACCESSORIES	ORDERING NOTES	
4.5 4.5 Watts 9.5 9.5 Watts 13 13 Watts	27 2700K W 3000K 35 3500K N 4000K C 5000K	VNS 16° Narrow Spot SP 19° Spot MF 30° Flood WF 46° Wide Flood	HL Honeycomb Louver 5 5' Wire Lead	Fixtures shipped with specified mounting hardware. If fixture is to be used in conjunction with Extended Arm Mount (EAM): Must specify with extended wire length	



PROFESSIONAL
OUTDOOR LIGHTING

www.VistaPro.com • email@vistapro.com • Fax: (888) 670-VISTA (8478)
1625 Surveyor Avenue • Simi Valley, CA 93063 • (805) 527-0987 • (800) 766-VISTA (8478)

Vista Professional Outdoor Lighting reserves the right to modify the design and/or construction of the fixture shown without further notification.



SPECIFICATIONS

HOUSING CONSTRUCTION:

Die-cast A360 aluminum. Optic and driver compartment environmentally sealed.

DOOR CONSTRUCTION:

Die-cast A360 aluminum.
Door is designed to shed water from the lens surface.

FINISH:

Powder coat finish available in Black, Architectural Bronze, Dark Bronze, Granite, White, Architectural Brick, Light Bronze, Special Bronze, Glossy Gray, Rust, Hunter Green, Weathered Bronze, Weathered Iron, Graphite Metallic, Verde, Pewter, Mocha and Olde Finish. Custom Powder coat finishes available on request.

LENS:

Tempered and beveled clear glass.

REFLECTOR:

Precision molded metalized optics combined with glare controlling filters. Very Narrow Spot optic incorporates an additional internal source shield to eliminate unwanted glare outside the beam pattern.

FASTENERS:

All fasteners are stainless steel.

WIRING:

Prewired with a 36" pigtail of 18-2 direct-burial cable and underground connectors.

MOUNTING:

Injection-molded composite knuckle with 1/2" NPS thread.

CERTIFICATION:

UL Listed to U.S. and Canadian safety standards for low voltage landscape luminaires (UL 1838).

LED:

Discreet performance LEDs binned to three MacAdam ellipses.
135 – 738 Lumens delivered.
4.5 – 13 Watts.

COLOR TEMPERATURE:

2700K, 3000K, 3500K, 4000K or 5000K CCT White.

COLOR RENDERING:

80 CRI minimum

ELECTRICAL:

Input voltage range 9 - 15 VAC.
Low voltage transformer required to operate (sold separately).

LIGHT DISTRIBUTION:

Very Narrow Spot **VNS** (16° FWHM)
Narrow Spot **NS** (19° FWHM)
Medium Flood **MF** (30° FWHM)
Wide Flood **WF** (46° FWHM)

DIMENSIONS

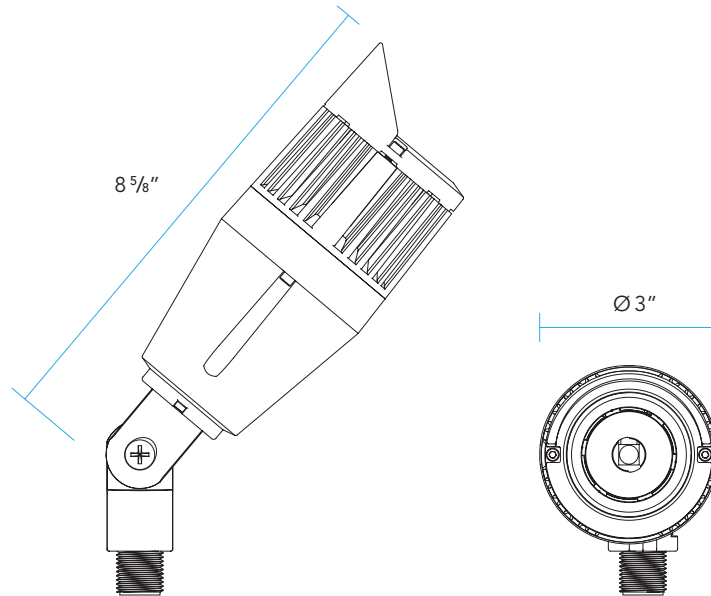



DELIVERED LUMENS

BEAM SPREAD	4.5 W	9.5 W	13 W
Very Narrow Spot VNS	135 Lumens	214 Lumens	269 Lumens
Narrow Spot NS	364 Lumens	566 Lumens	738 Lumens
Medium Flood MF	321 Lumens	487 Lumens	711 Lumens
Wide Flood WF	332 Lumens	542 Lumens	687 Lumens

