



MODEL 1142-GB | Specification Sheet
Commercial Series • Linear In-Grade • LED

TYPE: MODEL:
PROJECT:

PRODUCT FEATURES



Wattage	26 or 36 W
Voltage	120 or 277 VAC
Lumens	1821-3690 Delivered Lumens
Distribution	NEMA type [HxV]: 7x7 (WW), 7x4 (WG), 7x5 (NS), 7x5 (MF), 7x7 (WF)
CCT	2700K, 3000K, 3500K, 4000K, 5000K
CRI	80 CRI min.
Dimming	0-10V or Phase Cut (TRIAC/ELV-120VAC only) available
Driver	Dual Volt 120 or 277VAC with tri-modal dimming capabilities
Dimensions	26 ³ / ₈ " L x 4 ⁵ / ₈ " W x 7 ¹ / ₈ " D



ORDERING INFORMATION

EXAMPLE: 1142-GB-WW-27-A-DV-PCT-GS

MODEL	FINISH	DISTRIBUTION	COLOR TEMP	LUMENS	VOLTAGE	DIMMING	ACCESSORIES
1142	GB				DV		

MODEL	DOOR FINISH	DISTRIBUTION	COLOR TEMPERATURE	DELIVERED LUMENS
1142	GB Glass Border	WW Wall Wash	27 2700K	A 2000 (min.)
		WG Wall Grazer	30 3000K	B 3100 (min.)
		NS Narrow	35 3500K	
		MF Medium Flood	40 4000K	
		WF Wide Flood	50 5000K	
VOLTAGE	DIMMING	ACCESSORIES	ORDERING NOTES	
DV Dual Volt (120 or 277VAC)	ND Non Dimming 010 0-10V PCT Phase Cut (TRIAC/ELV-120VAC only)	GS Internal Glare Shield	Brushed stainless steel bezel option available. See 1142-SS specification.	



PROFESSIONAL
OUTDOOR LIGHTING

www.VistaPro.com • email@vistapro.com • Fax: (888) 670-VISTA (8478)
1625 Surveyor Avenue • Simi Valley, CA 93063 • (805) 527-0987 • (800) 766-VISTA (8478)

Vista Professional Outdoor Lighting reserves the right to modify the design and/or construction of the fixture shown without further notification.



SPECIFICATIONS

ROUGH-IN SECTION (RIS) CONSTRUCTION:

Extruded/injection molded polymeric body with molded polymeric junction box for maximum corrosion resistance. RIS features a flow thru recessed housing with a fully sealed junction box. Drive over rated when properly installed in concrete with rebar re-enforcement. Rebar attachment kit constructed from stainless steel bracketry permanently affixed to RIS. The junction box suitable for through branch circuiting.

OPTIC MODULE CONSTRUCTION:

Extruded/die cast aluminum construction, Type III hard anodized for maximum corrosion protection. Module is wet location listed, fully sealed with optics and integral drivers internal to the optic module. The optic module snaps into the RIS using two spring tempered stainless steel clips. Electrical connectors are made via outdoor rated cabling and watertight connectors.

REFLECTOR:

Specular or semi-specular extruded aluminum optics anodized and bright dipped for maximum reflectivity.

LENS:

10mm (.393") thick tempered and beveled clear glass. Permanently affixed and sealed to the optics housing with RTV silicon. Masked frit opening (black only). Brushed stainless steel bezel option available. See 1141-SS specification.

LED:

Mid-power linear LED driven at 1000mA or 1400mA.
2000+ or 3100+ Lumens delivered (1000+ or 1550+ per lineal foot).
26 or 36 Watts (11W or 19W per lineal foot).

COLOR TEMPERATURE:

2700K, 3000K, 3500K, 4000K or 5000K CCT White.

COLOR RENDERING:

80 CRI minimum

OPTICS/AIMING:

NEMA defined floodlight optics with wide lateral throws – extruded aluminum.

ACCESSORIES:

Internal Glare Shield **GS**.

FIXTURE CABLE:

- 18/3 SEOWW outdoor rated waterproof cable [for Non-dimmable and Phase Cut (TRIAC/ELV-120VAC only) options]
- 18/5 SJTOW outdoor rated waterproof cable [for 0-10V dimming option]

LOAD RATING:

Peak compressive force of **7,000 lbs.** This represents 90% of max load to load failure on average. Independent tests performed by SGS US Testing Company, Inc., an ISO 17025 accredited National Testing Laboratory.

CERTIFICATION:

CUL US wet location listed.
Ingress Protection Rating: IP68

DRIVER:

Dual Volt 120V or 277V equipped with tri-modal dimming capabilities.
Start up/Operating Temperature: -10°C to +50°C.
Non-dimmable, 0-10V and Phase Cut (TRIAC/ELV-120VAC only) options available.

LIGHT DISTRIBUTION:

Wall Wash (NEMA 7_Hx 7_V), Wall Grazer (NEMA 7_Hx 4_V),
Narrow (NEMA 7_Hx 5_V), Medium Flood (NEMA 7_Hx 5_V),
Wide Flood (NEMA 7_Hx 7_V) distributions available.

DIMENSIONS

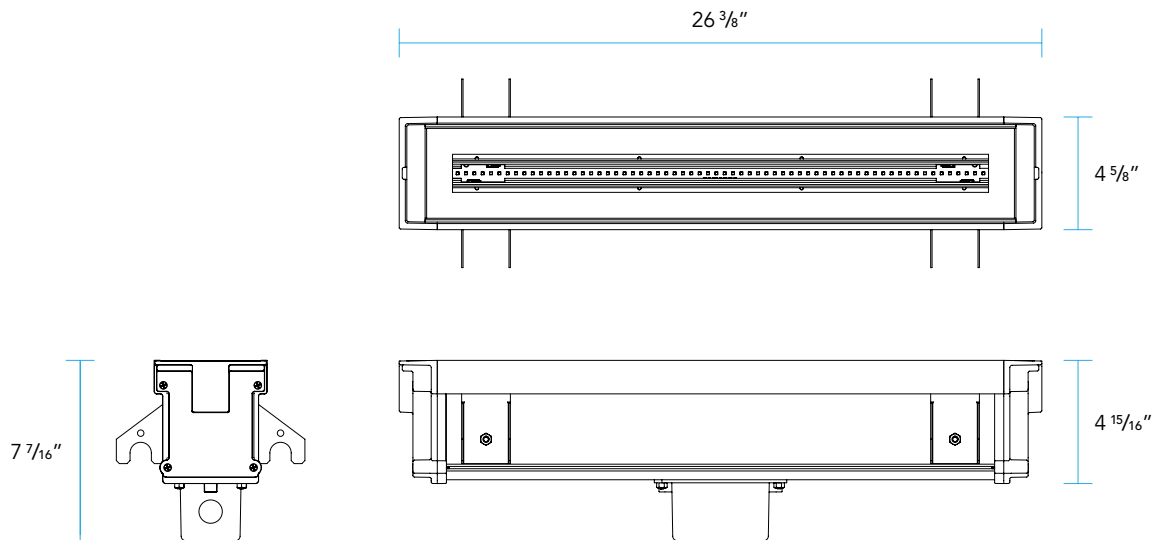



DELIVERED LUMENS PACKAGE SPECIFICATIONS

BEAM SPREAD	A	B
Wall Wash WW	26 Watts 2289 Lumens	35.6 Watts 3132 Lumens
Wall Grazer WG	26 Watts 2631 Lumens	35.6 Watts 3635 Lumens
Narrow NS	26 Watts 1821 Lumens	35.6 Watts 2553 Lumens
Medium Flood MF	26 Watts 2696 Lumens	35.6 Watts 3690 Lumens
Wide Flood WF	26 Watts 2307 Lumens	35.6 Watts 3099 Lumens

